

# Piranha

## Industrial Dewatering Pumps

### Selection Chart



Home Of Piranha Pumps [www.piranhapump.com](http://www.piranhapump.com)

Dewatering Model	H.P.	Ship WT.	Voltage	Phase	Discharge	Shut Off Head	Max. Volume
P 75 SS	.75	35	115/230	1	2"	39'	77 gpm
P 100 SS	1	38	115/230 230/460	1 & 3	2"	60'	90 gpm
P 150	1.5	58	115/230	1	2"	59'	140 gpm
P 150	1.5	58	230/460	3	2"	59'	140 gpm
P 200	2	65	115/230 230/460	1 & 3	2" & 3"	58'	180 gpm
PP250 HV	2.5	80	230/460	3	2"	50'	300 gpm
PP250 HH	2.5	80	230/460	3	2"	89'	150 gpm
P 300	3	91	230	1	3"	69'	325 gpm
P 450 HV	4.5	92	230/460	3	3"	72'	375 gpm
P450 HH	4.5	92	230/460	3	3"	108'	225 gpm
PP 500 HV	5	95	230/460	3	3"	92'	300 gpm
PP 500 HH	5	105	230/460	3	2"	175'	200 gpm
P 650 HV	6.5	107	230/460	3	3" & 4"	78'	500 gpm
P 650 HH	6.5	107	230/460	3	3" & 4"	113'	400 gpm
P 1000 HV	10	137	230/460	3	3" & 4"	120'	800 gpm
P 1000 HH	10	137	230/460	3	3" & 4"	160'	500 gpm
PP 1500 HV	15	220	230/460	3	4"	127'	800 gpm
PP 1500 HH	15	220	230/460	3	4"	200'	600 gpm
P 1500 HV	15	294	230/460	3	4" & 6"	115'	1100 gpm
P 1500 HH	15	294	230/460	3	4" & 6"	270'	300 gpm
P 2000 HV	20	304	230/460	3	4" & 6"	130'	1200 gpm
P 2000 HH	20	304	230/460	3	4" & 6"	295'	400 gpm
P 3000 HV	30	393	230/460	3	4" & 6"	138'	1800 gpm
P 3000 HH	30	393	230/460	3	4" & 6"	390'	500 gpm
P 4500 HV	45	404	460	3	4" & 6"	180'	1400 gpm
P 4500 HH	45	404	460	3	4" & 6"	455'	600 gpm

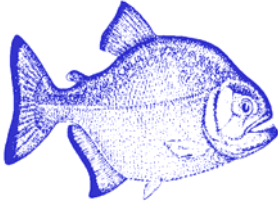

# Piranha

## Submersible Dewatering Pumps

### Model P-75-SS-1

**.75 HP / 2 Inch Discharge**  
**115/230v single phase**

Home Of Piranha Pumps [www.piranhapump.com](http://www.piranhapump.com)

#### *Pump Construction*

- Housing            Stainless Steel
- Mechanical Seals   Silicon Carbide
- Impeller            Cast iron
- Rotor Shaft        Stainless steel
- Diffuser            Cast iron, rubber liner
- Strainer            Stainless steel
- Hardware          Stainless steel
- Pump Weight      26 Lbs
- Lifting Handle     SS With Rubber Grip
- Dimensions        7 1/8" dia. X 13 1/4" H



#### *Motor Specifications*

- Rating              1 Phase .75 HP
- Voltage            115 Volt
- Current            F.L.A. 7 amps
- RPM                3450
- Power Cable      30'

**Piranha Model P-75-SS**  
.75 hp 115v 1 ph

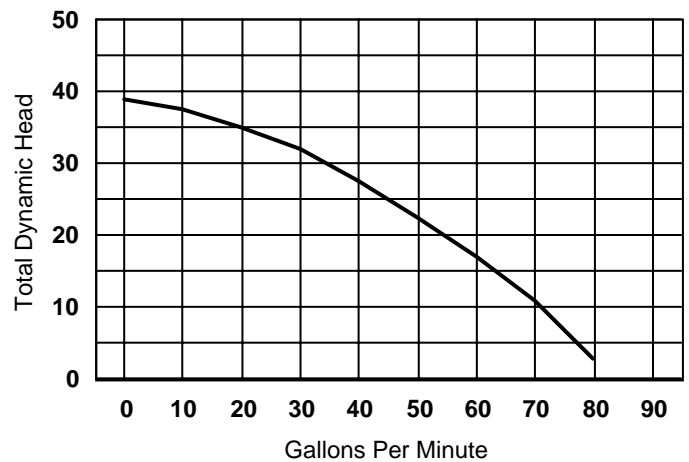

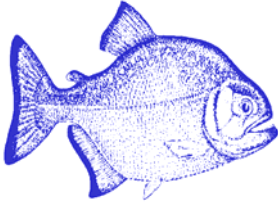

# Piranha

## Submersible Dewatering Pumps

### Model P-100-SS-1

**1 HP / 2 Inch Discharge**  
**115/230v single phase, 230/460v three phase**

Home Of Piranha Pumps [www.piranhapump.com](http://www.piranhapump.com)

#### *Pump Construction*

- Housing 304 Stainless Steel
- Mechanical Seals Silicon Carbide
- Impeller Cast iron
- Rotor Shaft 304 Stainless steel
- Diffuser Cast iron, rubber liner
- Strainer 304 Stainless steel
- Hardware 304 Stainless steel
- Pump Weight 37 Lbs
- Lifting Handle SS With Rubber Grip
- Dimensions 7 1/4" dia. X 14 1/4" H



#### *Motor Specifications*

- Rating 1 Phase 1 HP
- Voltage 115 Volt
- Current F.L.A. 11 amps
- RPM 3450
- Power Cable 30'

**Piranha Model P-100-SS**  
1 hp 115v 1ph

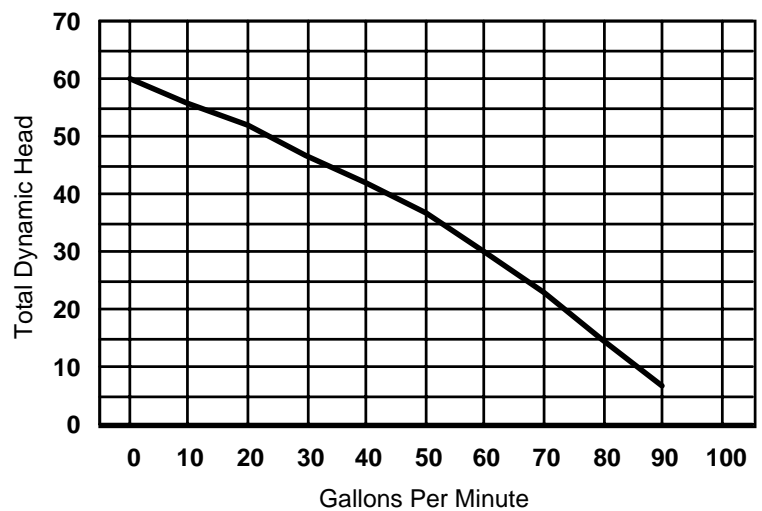

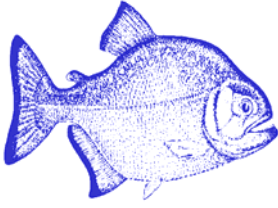

# Piranha

## Submersible Dewatering Pumps

### Model PP-100

**1 HP / 2 Inch Discharge**  
**115v single phase**

Home Of Piranha Pumps [www.piranhapump.com](http://www.piranhapump.com)

#### Pump Construction

Housing	356T6 & 6063T6 Al
Mechanical Seals	Carbon Ceramic
Impeller	Polyurethane
Rotor Shaft	416 SS
Suction Case	Polyurethane Liner
Strainer	316 SS, 3/16" Holes
Hardware	304 SS
Pump Weight	23 Lbs
Lifting Handle	
Male Camlock Discharge / F NPT	

#### Motor Specifications

Motor Seal	Buna-N Orings
Rating	1 HP, 1 phase
Voltage	115 Volt
Current	F.L.A. 10
Overload	Fuse
Motor Type	Capacitor Start / Run
RPM	3450
Insulation	Class B
Power Cable	25' 14/4 SOW-A
Control	NEMA 4

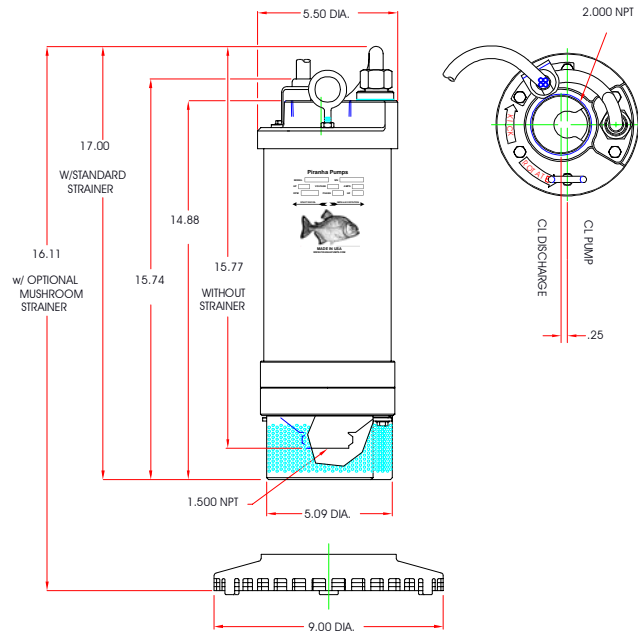

**Piranha Pump Model PP-100**  
**1 HP - 115 Volt 1 Phase**

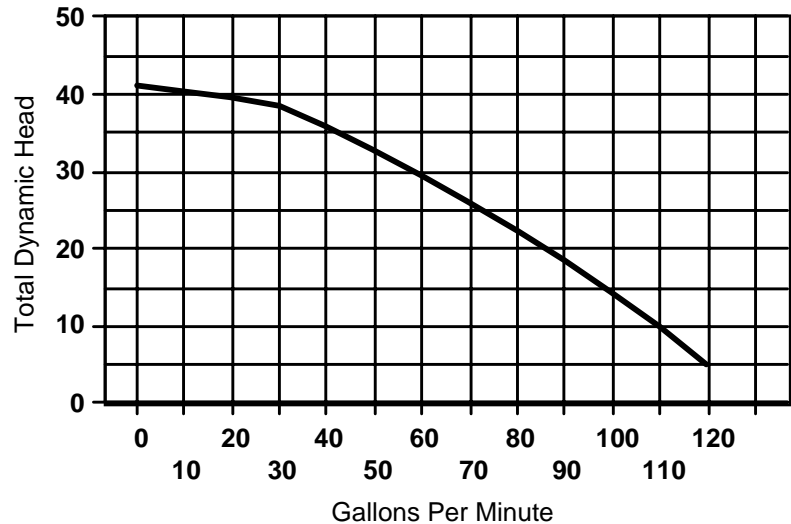

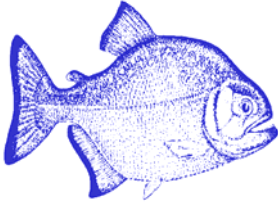

# Piranha

## Submersible Dewatering Pumps

### Model P-150

#### 1.5 HP / 2 Inch Discharge

#### 230v/460v/575v three phase

Home Of Piranha Pumps [www.piranhapump.com](http://www.piranhapump.com)

### *Pump Construction*

- Housing 356T6 Al Alloy
- Mechanical Seals Silicon Carbide
- Impeller Heat Treated 17-4 PH SS
- Rotor Shaft 416 SS
- Lower Diffuser Nitrile Rubber – Adjustable
- Discharge Lining Nitrile Rubber
- Strainer 316 SS 1/4" x 1" Openings
- Hardware 304 SS
- Pump Weight 36 Lbs
- Lifting Handle 3160SS With Rubber Grip



### *Motor Specifications*

- Motor Seal Double Oring
- Rating 3 Phase 1.5 HP
- Voltage 230 / 460 Volt
- Current F.L.A. 4.8 / 2.4
- Thermal Overload 2 Integral Switches
- Circuit Breaker Short Circuit, Locked Rotor & Overload Protection
- RPM 3450
- Insulation Class F / 310 Degrees F
- Power Cable 50' 14/4 SOW-A
- Control NEMA 4X

**Piranha Model P-150**  
1.5 HP - 230 / 460 Volt

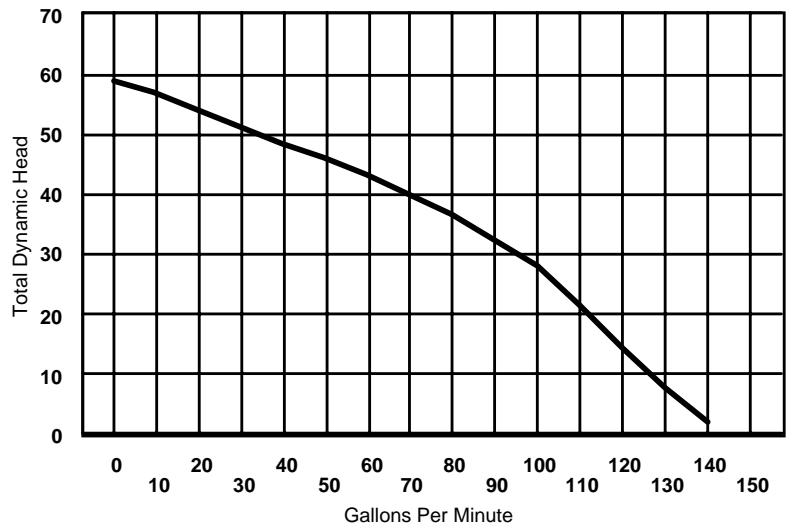

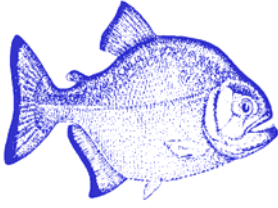

# Piranha

## Submersible Dewatering Pumps

### Model P-150

#### 1.5 HP / 2 Inch Discharge

#### 115v/230v single phase

Home Of Piranha Pumps [www.piranhapump.com](http://www.piranhapump.com)

### *Pump Construction*

- Housing 356T6 Al Alloy
- Mechanical Seals Silicon Carbide
- Impeller Heat Treated 17-4 PH SS
- Rotor Shaft 416 SS
- Lower Diffuser Nitrile Rubber – Adjustable
- Discharge Lining Nitrile Rubber
- Strainer 316 SS 1/4" x 1" Openings
- Hardware 304 SS
- Pump Weight 36 Lbs
- Lifting Handle 316 SS With Rubber Grip



### *Motor Specifications*

- Motor Seal Double Oring
- Rating 1 Phase 1.5 HP
- Voltage 115 / 230 Volt
- Current F.L.A. 13.5 / 6.8
- Thermal Overload 2 Integral Switches
- Circuit Breaker Short Circuit, Locked Rotor, & Overload Protection
- RPM 3450
- Insulation Class F / 310 Degrees F
- Power Cable 50' 14/4 SOW-A
- Control NEMA 4X

**Piranha Model P-150**  
1.5 HP - 115 / 230 Volt

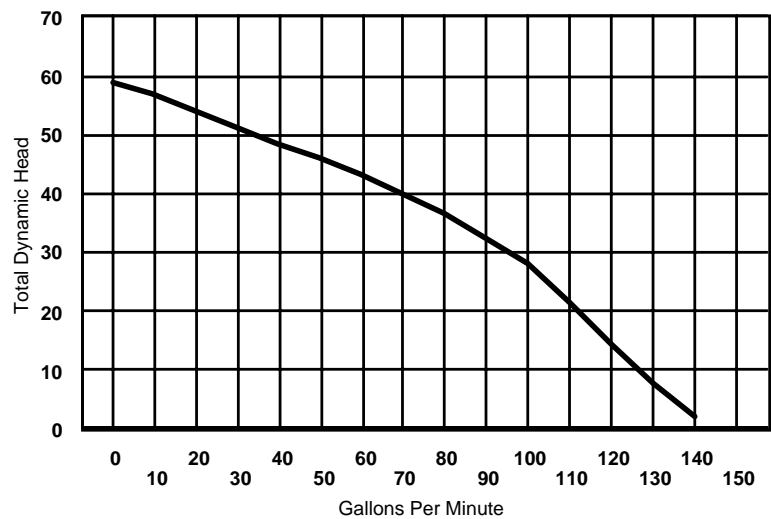

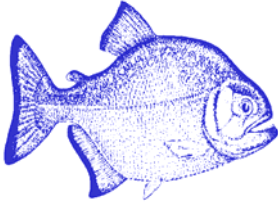

# Piranha

## Submersible Dewatering Pumps

### Model P-200

**2 HP / 2 & 3 Inch Discharge**  
**115v/230v single phase, 230v/460v three phase**

Home Of Piranha Pumps [www.piranhapump.com](http://www.piranhapump.com)

### *Pump Construction*

- Housing Stainless Steel
- Mechanical Seals Silicon Carbide
- Impeller Cast iron
- Rotor Shaft 416 SS
- Suction Case Hardened Cast Iron, Rubber Lined  
Abrasion Resistant
- Strainer Stainless Steel 3/8" Openings
- Hardware Stainless Steel
- Pump Weight 53 Lbs
- Discharge 2 & 3 inch male NPT
- Dimensions 9" dia. X 17" H



### *Motor Specifications*

- Motor Seal Buna-N Orings
- Rating 2 HP
- Voltage 115/230 1 ph, 230/460 3 ph
- Current F.L.A. 16.4/8.3 1 ph, 6/3 3ph
- Overload Integral
- RPM 3450
- Insulation Class F
- Power Cable 50' With Strain Relief

Piranha model P-200  
2 hp, 115/230 1 ph, 230/460 3 ph

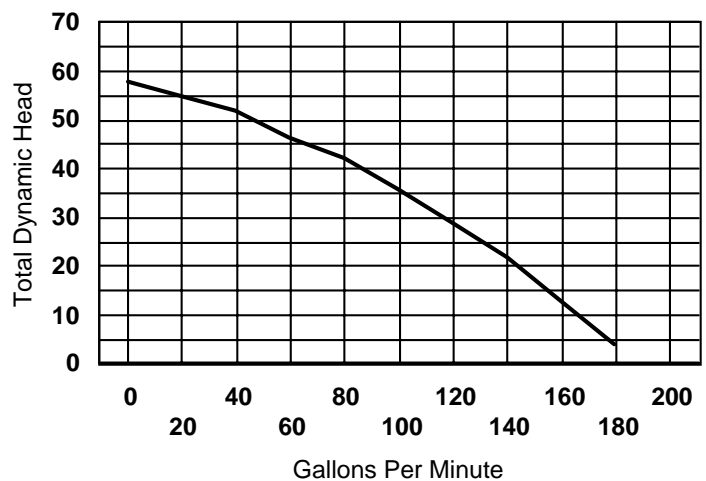

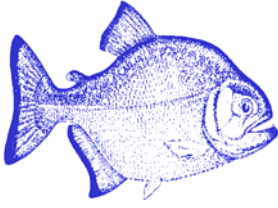

# Piranha

## Submersible Dewatering Pump

### Model PP-250-HV & HH

### 2.5 HP / 2 Inch Discharge

### 230v/460v three phase

Home Of Piranha Pumps [www.piranhapump.com](http://www.piranhapump.com)

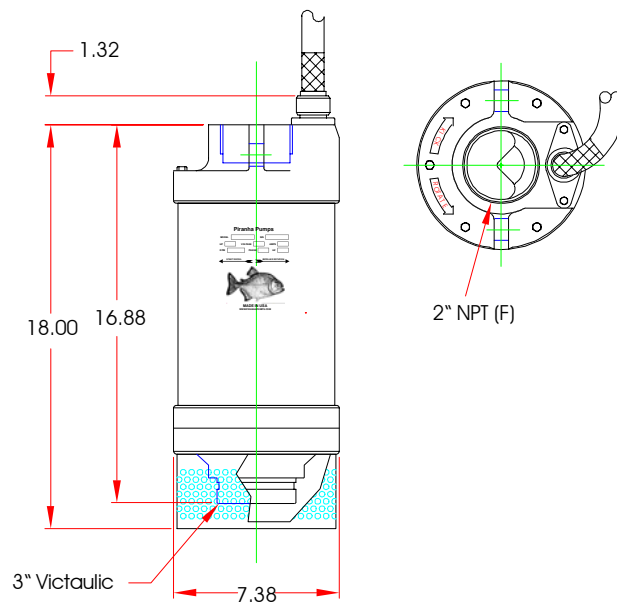

#### Pump Construction

Housing	356T6 & 6063T6 Al Alloy Hard Anodized
Mechanical Seals	Silicon Carbide
Impeller	17-4PH Stainless Steel Hardened – Heat Treated
Rotor Shaft	416 SS
Suction Case	Polyurethane Liner Abrasion Resistant
Strainer	316 SS 1/4" Openings
Hardware	304 SS
Pump Weight	50 Lbs
Discharge	2 inch Female NPT

#### Motor Specifications

Motor Seal	Buna-N Orings
Rating	3 Phase 2.5 HP
Voltage	230/460 Volt
Current	F.L.A. 7.8 / 3.9
Overload	Circuit Breaker
RPM	3450
Insulation	Class F
Power Cable	50' 12/4 SOW-A With Strain Relief
Control	NEMA 3R OR NEMA 4

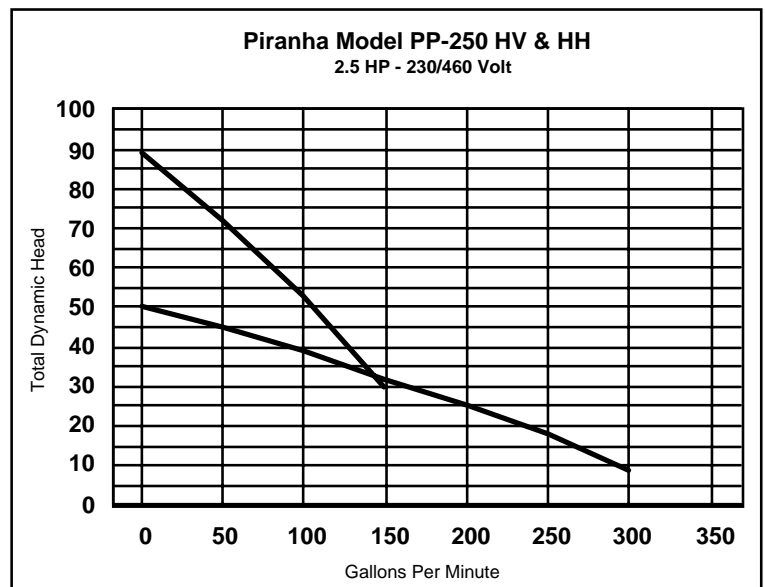



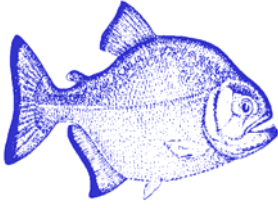

# Piranha

## Submersible Dewatering Pumps

### Model P-300

### 3 HP / 3 Inch Discharge

### 230v single phase

Home Of Piranha Pumps [www.piranhapump.com](http://www.piranhapump.com)

#### *Pump Construction*

- Housing 356T6 Al Alloy
- Mechanical Seals Silicon Carbide
- Impeller Heat Treated 17-4 PH SS
- Rotor Shaft 416 SS
- Lower Diffuser Nitrile Rubber – Adjustable
- Discharge Lining Nitrile Rubber
- Strainer 316 SS 1/4" x 1" Openings
- Hardware 304 SS
- Pump Weight 66 Lbs
- Lifting Handle 316 SS With Rubber Grip



#### *Motor Specifications*

- Motor Seal Double Oring
- Rating 1 Phase 3 HP
- Voltage 230 Volt
- Current F.L.A. 13.5
- Thermal Overload 2 Integral Switches
- Circuit Breaker Short Circuit, Locked Rotor, & Overload Protection
- RPM 3450
- Insulation Class F / 310 Degrees F
- Power Cable 50' 12/4 SOW-A
- Control NEMA 4X

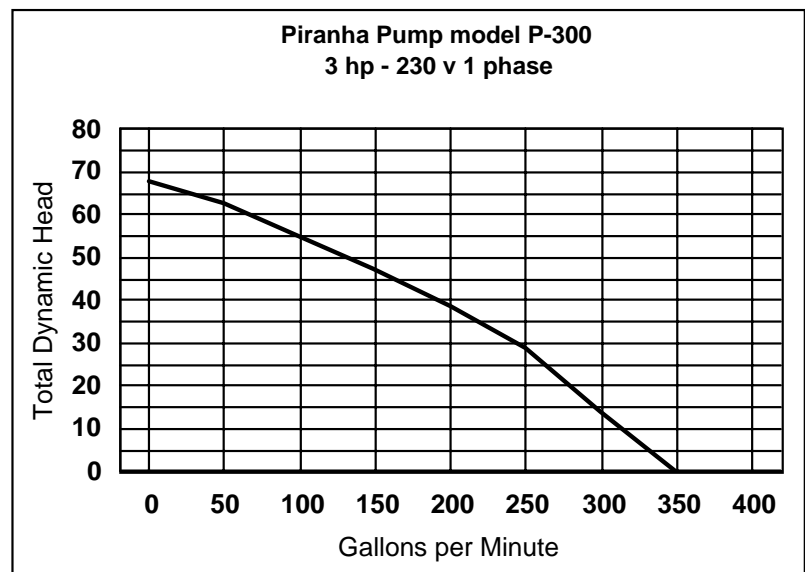

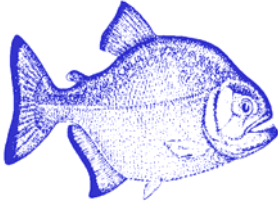

# Piranha

## Submersible Dewatering Pumps

### Model P-450 HV & HH

### 4.5 HP / 3 Inch Discharge

### 230v/460v/575v three phase

Home Of Piranha Pumps [www.piranhapump.com](http://www.piranhapump.com)

#### Pump Construction

- Housing 356T6 Al Alloy
- Mechanical Seals Silicon Carbide
- Impeller Heat Treated 17-4 PH SS
- Rotor Shaft 416 SS
- Lower Diffuser Nitrile Rubber – Adjustable
- Discharge Lining Nitrile Rubber
- Strainer 316 SS 1/4" x 1" Openings
- Hardware 304 SS
- Pump Weight 66 Lbs
- Lifting Handle 316 SS With Rubber Grip



#### Motor Specifications

- Motor Seal Double Oring
- Rating 3 Phase 4.5 HP
- Voltage 230 / 460 Volt
- Current F.L.A. 13 / 6.5
- Thermal Overload 2 Integral Switches
- Circuit Breaker Short Circuit, Locked Rotor, & Overload Protection
- RPM 3450
- Insulation Class F / 310 Degrees F
- Power Cable 50' 12/4 SOW-A
- Control NEMA 4X

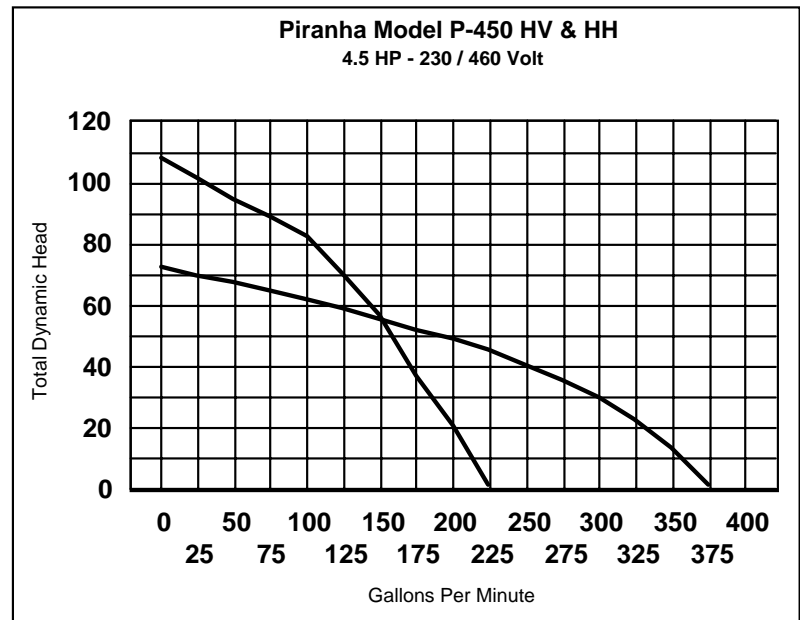

PIRANHA PUMPS ARE MADE BY: EQUIPMENT SPECIALTIES CO. ALBUQUERQUE, NM  
 PHONE: (505) 822-0449 FAX: (505) 858-0171

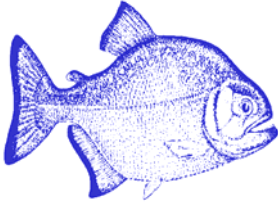

# Piranha

## Submersible Dewatering Pump

### Model PP-500-HV

#### 5 HP / 3 Inch Discharge

#### 230v/460v three phase

Home Of Piranha Pumps [www.piranhapump.com](http://www.piranhapump.com)

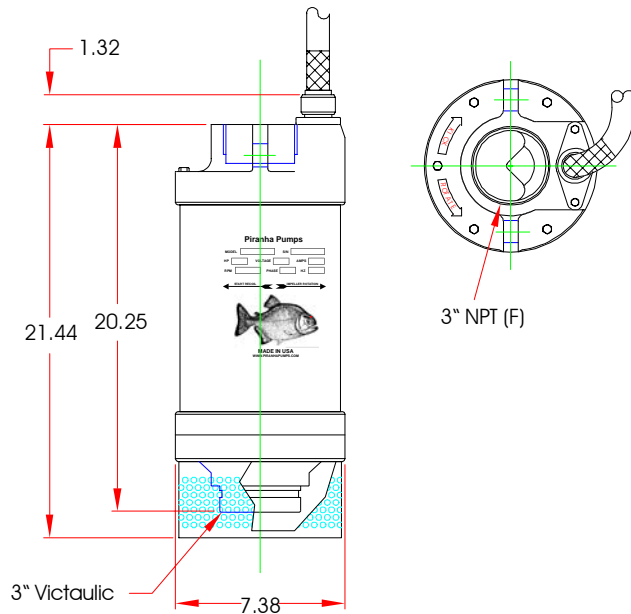

#### Pump Construction

Housing	356T6 & 6063T6 Al Alloy Hard Anodized
Mechanical Seals	Silicon Carbide
Impeller	17-4PH Stainless Steel Hardened – Heat Treated
Rotor Shaft	416 SS
Suction Case	Polyurethane Liner Abrasion Resistant
Strainer	316 SS 1/4" Openings
Hardware	304 SS
Pump Weight	64 Lbs
Discharge	3 inch Female NPT

#### Motor Specifications

Motor Seal	Buna-N Orings
Rating	3 Phase 5 HP
Voltage	230/460 Volt
Current	F.L.A. 15.5 / 7.8
Overload	Circuit Breaker
RPM	3450
Insulation	Class F
Power Cable	50' 12/4 SOW-A With Strain Relief
Control	NEMA 3R OR NEMA 4

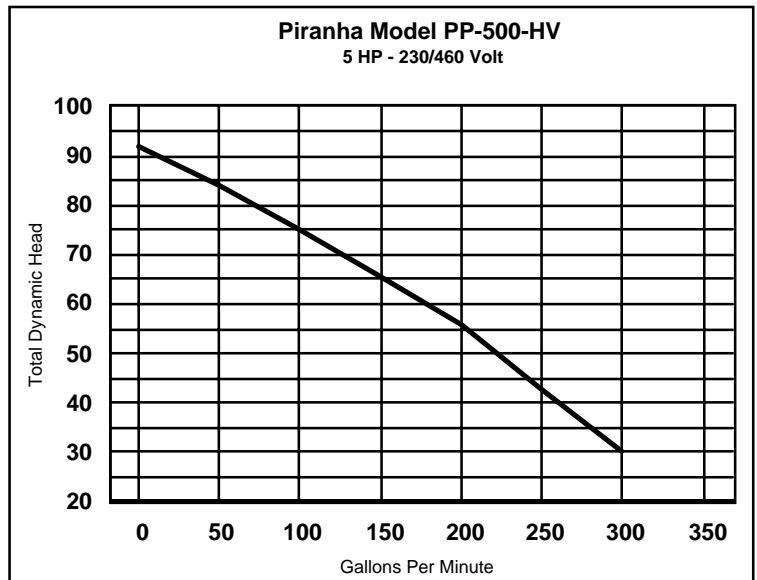

PIRANHA PUMPS ARE MADE BY: EQUIPMENT SPECIALTIES CO. ALBUQUERQUE, NM  
 PHONE: (505) 822-0449 FAX: (505) 858-0171

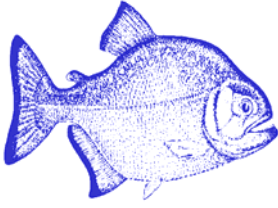

# Piranha

## Submersible Dewatering Pump

### Model PP-500-HH

### 5 HP / 2 Inch Discharge

### 230v/460v three phase

Home Of Piranha Pumps [www.piranhapump.com](http://www.piranhapump.com)

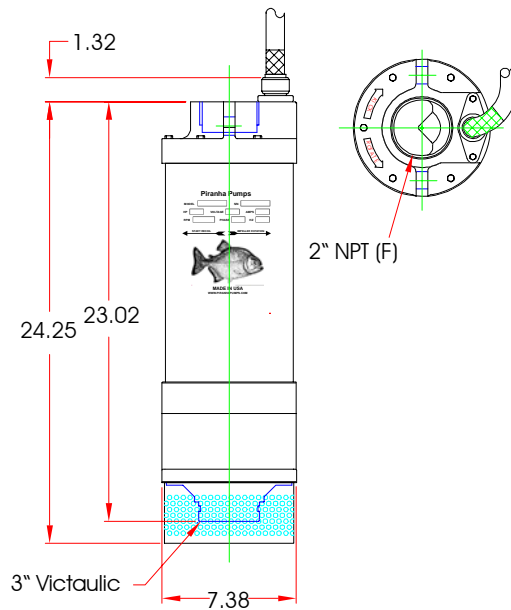

#### Pump Construction

Housing	356T6 & 6063T6 Al Alloy Hard Anodized
Mechanical Seals	Silicon Carbide
Impeller	17-4PH Stainless Steel Hardened – Heat Treated
Rotor Shaft	416 SS
Suction Case	Polyurethane Liner Abrasion Resistant
Strainer	316 SS 1/4" Openings
Hardware	304 SS
Pump Weight	73 Lbs
Discharge	2 inch Female NPT

#### Motor Specifications

Motor Seal	Buna-N Orings
Rating	3 Phase 5 HP
Voltage	230/460 Volt
Current	F.L.A. 15.2 / 7.6
Overload	Circuit Breaker
RPM	3450
Insulation	Class F
Power Cable	50' 12/4 SOW-A With Strain Relief
Control	NEMA 3R OR NEMA 4

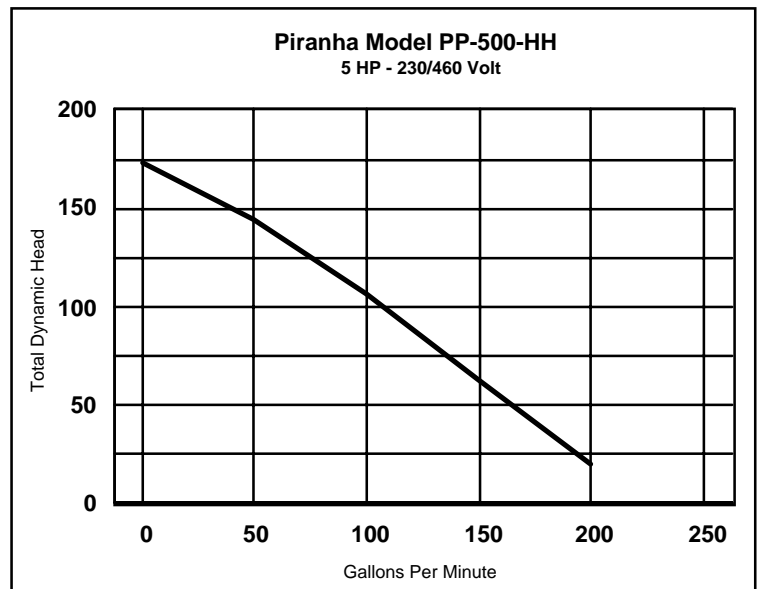

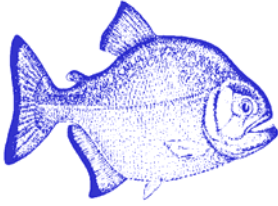

# Piranha

## Submersible Dewatering Pumps

### Model P-650

### 6.5 HP / 3 & 4 Inch Discharge

### 230v/460v/575v three phase

Home Of Piranha Pumps [www.piranhapump.com](http://www.piranhapump.com)

#### *Pump Construction*

- Housing 356T6 Al Alloy
- Mechanical Seals Silicon Carbide
- Impeller Heat Treated 17-4 PH SS
- Rotor Shaft 416 SS
- Lower Diffuser Nitrile Rubber – Adjustable
- Discharge Lining Nitrile Rubber
- Strainer 316 SS 1/4" x 1" Openings
- Hardware 304 SS
- Pump Weight 80 Lbs
- Lifting Handle 316 SS With Rubber Grip
- Dimensions: HV 25.5" H x 10.75" D
- Dimensions: HH 22.75" H x 10" D



#### *Motor Specifications*

- Motor Seal Double Oring
- Rating 3 Phase 6.5 HP
- Voltage 230 / 460 Volt
- Current F.L.A. 17.8 / 8.9
- Thermal Overload 2 Integral Switches
- Circuit Breaker Short Circuit, Locked Rotor, & Overload Protection
- RPM 3450
- Insulation Class F / 310 Degrees F
- Power Cable 50' 12/4 SOW-A
- Control NEMA 4X

**Piranha Model P-650 HV & HH**  
 6.5 HP - 230 / 460 Volt

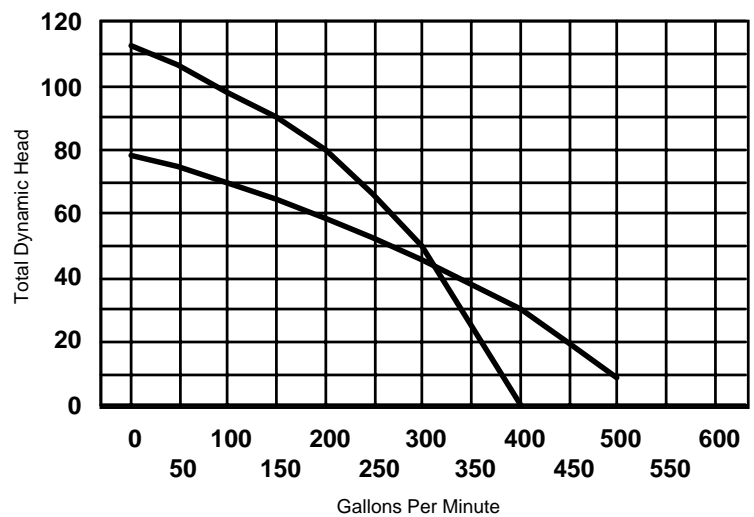

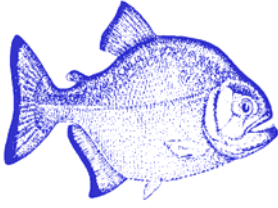

# Piranha

## Submersible Dewatering Pumps

### Model P-1000

### 10 HP / 3 & 4 Inch Discharge

### 230v/460v/575v three phase

Home Of Piranha Pumps [www.piranhapump.com](http://www.piranhapump.com)

#### *Pump Construction*

- Housing 356T6 Al Alloy
- Mechanical Seals Silicon Carbide
- Impeller Heat Treated 17-4 PH SS
- Rotor Shaft 416 SS
- Lower Diffuser Nitrile Rubber – Adjustable
- Discharge Lining Nitrile Rubber
- Strainer 316 SS 1/3" x 1 1/3" Openings
- Hardware 304 SS
- Pump Weight 117 Lbs
- Lifting Handle 316 SS With Rubber Grip



#### *Motor Specifications*

- Motor Seal Double Oring
- Rating 3 Phase 10 HP
- Voltage 230 / 460 Volt
- Current F.L.A. 35 / 17.5
- Thermal Overload 2 Integral Switches
- Circuit Breaker Short Circuit, Locked Rotor, & Overload Protection
- RPM 3450
- Insulation Class F / 310 Degrees F
- Power Cable 50' 10/5 SOW-A
- Control NEMA 4X

Piranha Model P-1000 HV & HH  
 10 HP - 230 / 460 V

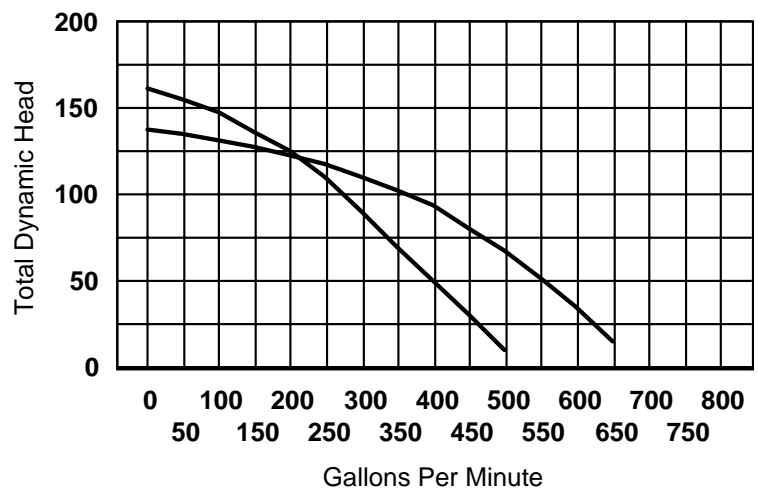

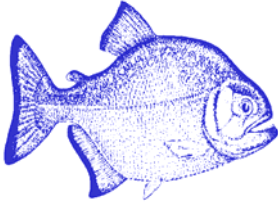

# Piranha

## Submersible Dewatering Pumps

### Model P-1500

#### 15 HP / 4 & 6 Inch Discharge

#### 230v/460v/575v three phase

Home Of Piranha Pumps [www.piranhapump.com](http://www.piranhapump.com)

### Pump Construction

- Housing 356T6 Al Alloy
- Mechanical Seals Silicon Carbide
- Impeller Heat Treated 17-4 PH SS
- Rotor Shaft 416 SS
- Lower Diffuser Nitrile Rubber – Adjustable
- Discharge Lining Nitrile Rubber
- Strainer 316 SS 3/8"x1 1/4" Openings
- Hardware 304 SS
- Pump Weight 220 Lbs
- Lifting Handle 316 SS With Rubber Grip



### Motor Specifications

- Motor Seal Double Oring
- Rating 3 Phase 15 HP
- Voltage 230 / 460 Volt
- Current F.L.A. 40 / 20
- Thermal Overload 2 Integral Switches
- Circuit Breaker Short Circuit, Locked Rotor, & Overload Protection
- RPM 3450
- Insulation Class F / 310 Degrees F
- Power Cable 50' 6/3 SOW-A
- Control NEMA 4X

Piranha Model P-1500 HV & HH  
15 HP - 230 / 460 Volt



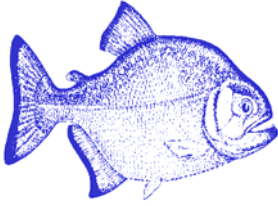

# Piranha

## Submersible Dewatering Pump

### Model PP-1500-HV & HH

### 15 HP / 4 Inch Discharge

### 230v/460v three phase

Home Of Piranha Pumps [www.piranhapump.com](http://www.piranhapump.com)

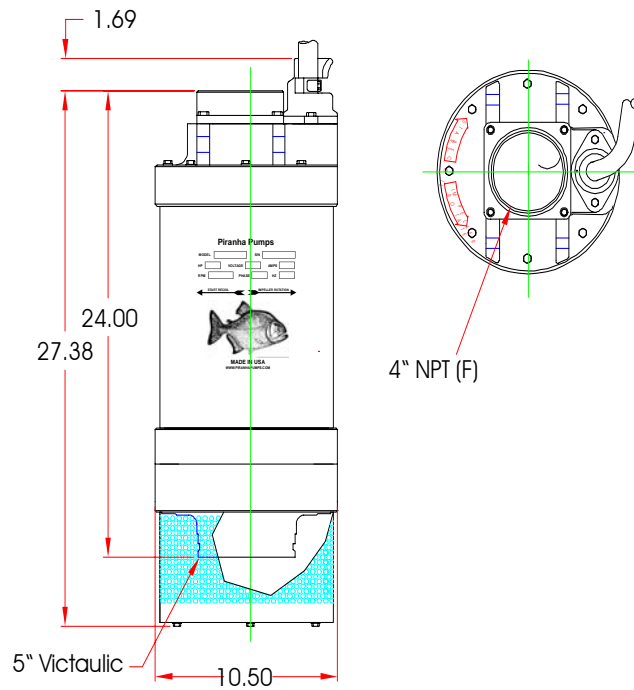

#### Pump Construction

Housing	356T6 & 6063T6 Al Alloy Hard Anodized
Mechanical Seals	Silicon Carbide
Impeller	17-4PH Stainless Steel Hardened – Heat Treated
Rotor Shaft	416 SS
Suction Case	Polyurethane Liner Abrasion Resistant
Strainer	316 SS 1/4" Openings
Hardware	304 SS
Pump Weight	150 Lbs
Discharge	4 inch Female NPT

#### Motor Specifications

Motor Seal	Buna-N Orings
Rating	3 Phase 15 HP
Voltage	230/460 Volt
Current	F.L.A. 39.5 / 19.7
Overload	Circuit Breaker
RPM	3450
Insulation	Class F
Power Cable	50' 6/4 , 12/4 SOW-A
Control	NEMA 3R OR NEMA 4

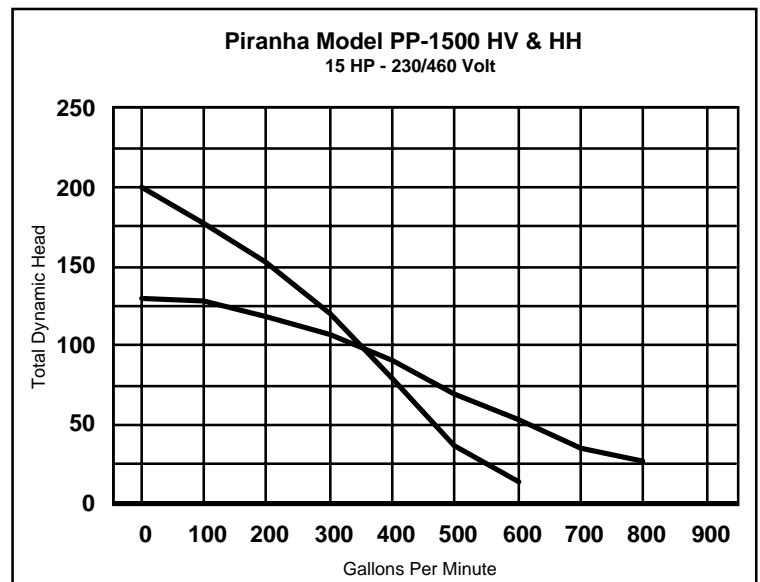



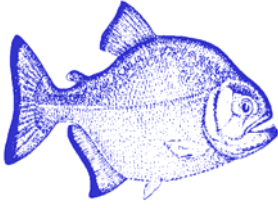

# Piranha

## Submersible Dewatering Pumps

### Model P-2000

#### 20 HP / 4 & 6 Inch Discharge

#### 230v/460v/575v three phase

Home Of Piranha Pumps [www.piranhapump.com](http://www.piranhapump.com)

### *Pump Construction*

- Housing 356T6 Al Alloy
- Mechanical Seals Silicon Carbide
- Impeller Heat Treated 17-4 PH SS
- Rotor Shaft 416 SS
- Lower Diffuser Nitrile Rubber – Adjustable
- Discharge Lining Nitrile Rubber
- Strainer 316 SS 3/8"x1 1/4" Openings
- Hardware 304 SS
- Pump Weight 230 Lbs
- Lifting Handle 316 SS With Rubber Grip



### *Motor Specifications*

- Motor Seal Double Oring
- Rating 3 Phase 20 HP
- Voltage 230 / 460 Volt
- Current F.L.A. 42 / 21
- Thermal Overload 2 Integral Switches
- Circuit Breaker Short Circuit, Locked Rotor, & Overload Protection
- RPM 3450
- Insulation Class F / 310 Degrees F
- Power Cable 50' 6/3 SOW-A
- Control NEMA 4X

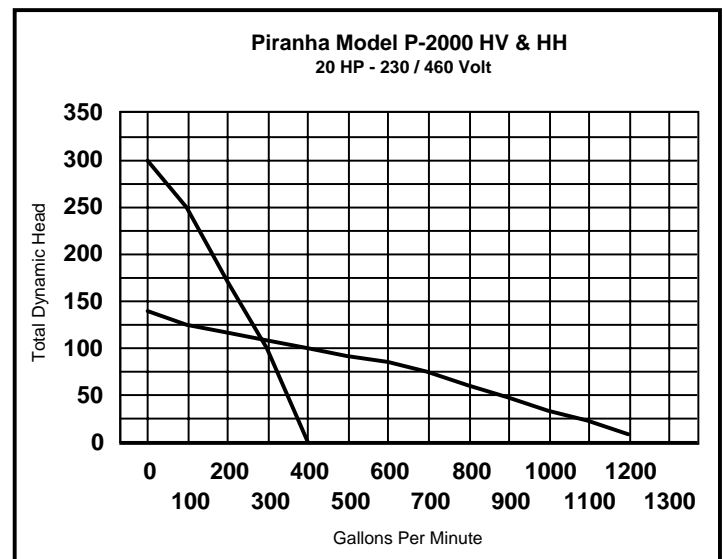

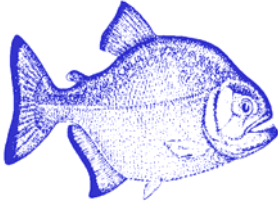

# Piranha

## Submersible Dewatering Pumps

### Model P-3000

### 30 HP / 4 & 6 Inch Discharge

### 230v/460v/575v three phase

Home Of Piranha Pumps [www.piranhapump.com](http://www.piranhapump.com)

#### *Pump Construction*

- Housing 356T6 Al Alloy
- Mechanical Seals Silicon Carbide
- Impeller Heat Treated 17-4 PH SS
- Rotor Shaft 416 SS
- Lower Diffuser Nitrile Rubber – Adjustable
- Discharge Lining Nitrile Rubber
- Strainer 316 SS 3/8"x1 1/4" Openings
- Hardware 304 SS
- Pump Weight 320 Lbs
- Lifting Handle 316 SS With Rubber Grip



#### *Motor Specifications*

- Motor Seal Double Oring
- Rating 3 Phase 30 HP
- Voltage 230 / 460 Volt
- Current F.L.A. 80 / 40
- Thermal Overload 2 Integral Switches
- Circuit Breaker Short Circuit, Locked Rotor, & Overload Protection
- RPM 3450
- Insulation Class F / 310 Degrees F
- Power Cable 50' 6/3 SOW-A
- Control NEMA 4X

**Piranha Model P-3000 HV & HH**  
 30 HP - 230 / 460 Volt

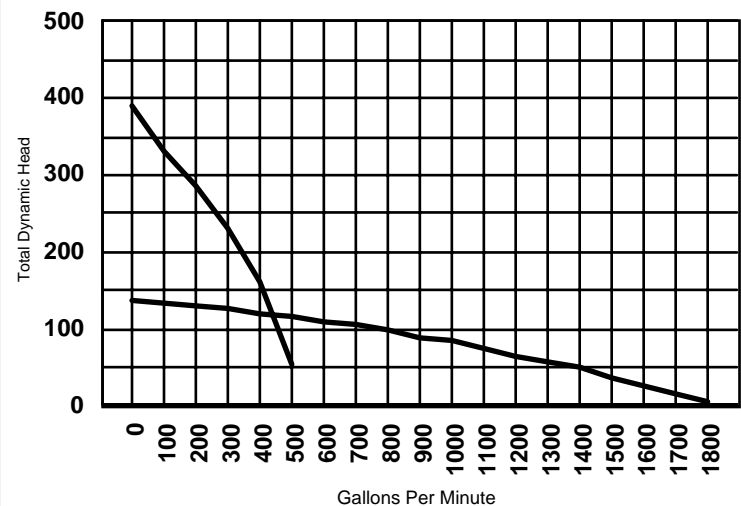

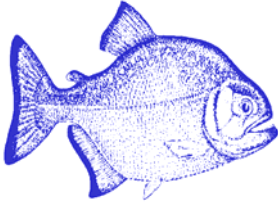

# Piranha

## Submersible Dewatering Pumps

### Model P-4500

#### 45 HP / 4 & 6 Inch Discharge

#### 460v/575v three phase

Home Of Piranha Pumps [www.piranhapump.com](http://www.piranhapump.com)

### *Pump Construction*

- Housing 356T6 Al Alloy
- Mechanical Seals Silicon Carbide
- Impeller Heat Treated 17-4 PH SS
- Rotor Shaft 416 SS
- Lower Diffuser Nitrile Rubber – Adjustable
- Discharge Lining Nitrile Rubber
- Strainer 316 SS 3/8"x1 1/4" Openings
- Hardware 304 SS
- Pump Weight 390 Lbs
- Lifting Handle 316 SS With Rubber Grip



### *Motor Specifications*

- Motor Seal Double Oring
- Rating 3 Phase 45 HP
- Voltage 460 Volt
- Current F.L.A. 54
- Thermal Overload 2 Integral Switches
- Circuit Breaker Short Circuit, Locked Rotor, & Overload Protection
- RPM 3450
- Insulation Class F / 310 Degrees F
- Power Cable 50' 6/3 SOW-A
- Control NEMA 4X

